

Summer Orienteering



Are you up for the challenge?

Leaders from 1st North Leigh Scout Group have put together this orienteering route that takes you in and around North Leigh, and we hope you have fun completing it in August!

Please read all of the attached instructions before you set off on your adventure!

Please also note that all young people must be accompanied by a responsible parent or guardian and that 1st North Leigh Scout Group takes no responsibility for participants as this activity is to be completed independently.

A few quick points about safety:

- Young people must have a parent or guardian with them at all times
- Keep to footpaths, bridleways, and public right of ways - the route DOES NOT take you onto any private property
- Follow the countryside code, which at it's simplest is :
 - ⇒ Take all litter home with you
 - ⇒ Leave gates as you found them
 - ⇒ Keep dogs on their lead and under control (especially around livestock)
- The route takes you across a few roads (this has been kept to a minimum). Work out where you need to go at a safe distance from the road before crossing, and stay alert while you do cross.

#SkillsForLife

As Scouts, we believe in preparing young people with skills for life, so it would be great if you could let your young person lead the orienteering as much as possible!

Read through the guidance with them to refresh their memory of how to read a map and compass, and maybe even get them to do a quick practise before you set off.

It would be great if everyone walking could look through the instructions to learn too, that way they can help the young person if they struggle!

You will need the following packed in a small backpack :

- Print out:
 - Instructions from this pack
 - Directions and questions
 - Blank map of North Leigh
 - Map with route on (to be used in case you get really really lost)
- Pen and pencil (plus spares)
- Plenty of water
- Sun hat and sun cream
- Lunch
- Snacks
- Compass (an actual compass is best, but a compass app on a phone can work too)
- Phone (with charge and the what3words app)
- Raincoat (we live in the UK after all!)
- Small first aid kit
- Hand sanitiser (for before you eat!)
- Wear clothes comfortable to walk in (preferably layers) and comfortable walking shoes/boots

About the Route

Start/Finish

The route is circular, and starts and ends at the Turner Hall carpark, which is free to park in. It is nearly opposite St. Mary's Church, at the bottom of Church Road, North Leigh, and has the postcode of OX29 6TX. Please note that there are no toilets on this route!

Distance and Time

There are two routes - we think the shorter route will be best for Beavers and Cubs, and the longer route for Scouts and Explorers. Of course, if your Beaver/Cub is feeling adventurous feel free to do the longer route!

Shorter route: 8km, roughly 4-5 hours (including breaks)

Longer route: 12km, roughly 5-6 hours (including breaks)

Terrain

Both routes are mainly on footpaths, which are either flat or have gentle inclines. They mainly go through fields or wooded areas, but also have a few concrete paths.

Orienteering Questions

Along the route you have questions to answer! Simply fill the answers in the table when you get to that point along your walk.

Can I get a badge for this?

Before you set off, have a look at the Navigator staged badge on scouts.org.uk/staged-badges/navigator - lots of things you'll do count towards stages 1-3. Make sure you take plenty of photos as evidence, then you can email them to your section leader when you get back!

What do I do now?

Make sure you've read the first page, then also read the next couple of pages to refresh yourself of how to navigate using a map and compass. It's a good idea to get everyone who will be walking with you to have a read, as they might like a go too!

Most importantly, remember to have fun, and enjoy yourself on a walk through the Great British countryside!



Ash



Beech



Birch



Hawthorn



Hazel



Horse Chestnut



Oak

Map and Compass Basics

There are four compass points (North, East, South, and West), with the points between them named after the two nearest points. (The red end of the compass needle usually points north).

The top of the map will always be North, however you must orientate the map so that it matches the direction that North actually is. To do this, simply use your compass to find North and spin your map so that the top points in that direction!

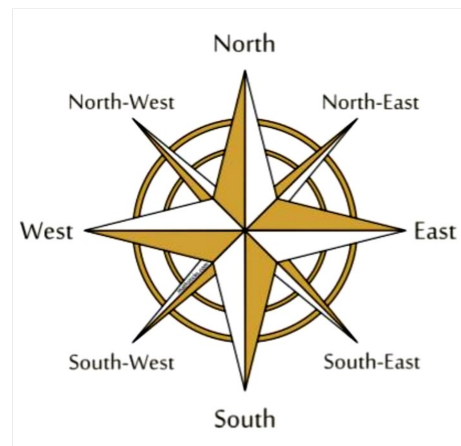

Simple Key for the Map

Footpath

Bridleway

Recreational Route

Place of worship with tower

Coniferous Trees

Non-coniferous Trees

Minor Road (under 4m wide)

Single Carriageway Main Road

Grid References

If you look at your map, you'll see some faint blue lines, which make up a grid.

You always read the number along the top/bottom, then the number at the side - **along the corridor (horizontal), and then up the stairs (vertical).**

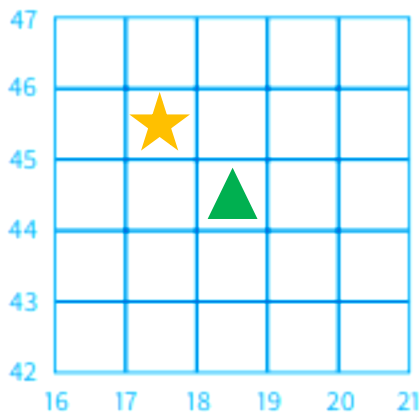

4-Figure Grid References

We'll start with 4-figure grid references. The green triangle in the diagram is 18 across and 44 up, so the 4-figure grid reference is 1844.

Try to locate the orange star, you should get 1745.

6-Figure Grid References

Now imagine each of the squares in the above diagram are divided further into tenths. The diagram to the right shows the box that the green triangle is in, which is 1844.

To locate the blue box (diagram to the right), we know it is in 1844, but more accurately it is 7 tenths across and 8 tenths up within that grid square. This means the 6-figure grid reference is 187448.

Try to locate the red circle, you should get 185443.

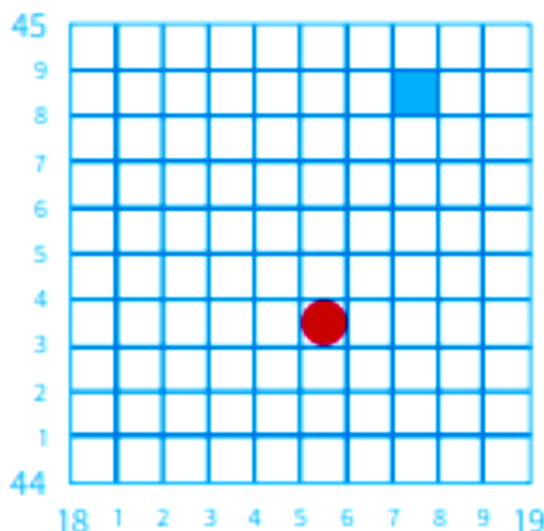

Contour Lines

Contour lines can be used to understand the shape of the land. They're drawn between points of equal height, so any single contour line will be at the same height all the way along its length.

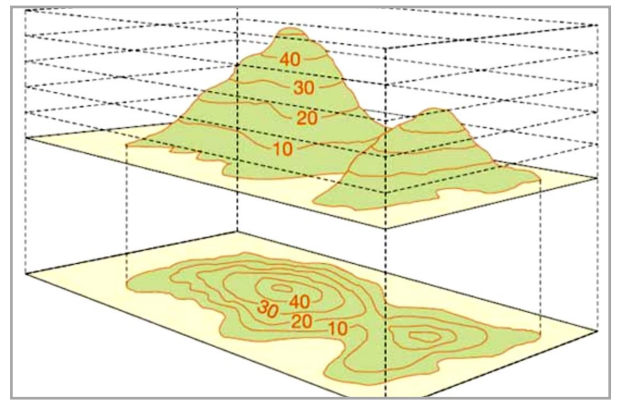

Bearings

Bearings are an accurate way to give directions, written as 3 digit number and represent the 360 degrees of a circle.

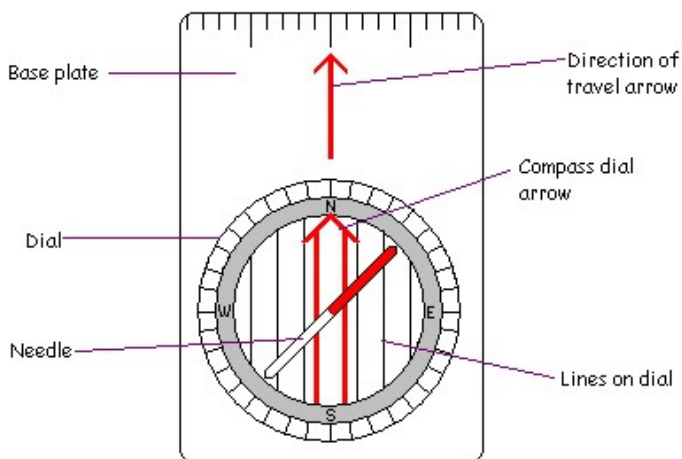

To follow a bearing, turn the outer dial until the bearing (e.g. 140° SE) is lined up with the direction of travel arrow.

Spin your body slowly until the north/red side of the needle lines up with the compass dial arrow/ where N is on the dial.

Keep these two lined up, and move in the direction of travel, ensuring you hold the compass flat.

what3words

Each 3m square in the world has a unique 3 word address, and gives a simple way to share specific locations. Download the app before you leave, and then:



1. Enter the what3words into the search bar with a dot between each word and press Go
2. Tap Navigate
3. Select your preferred navigation app to get directions

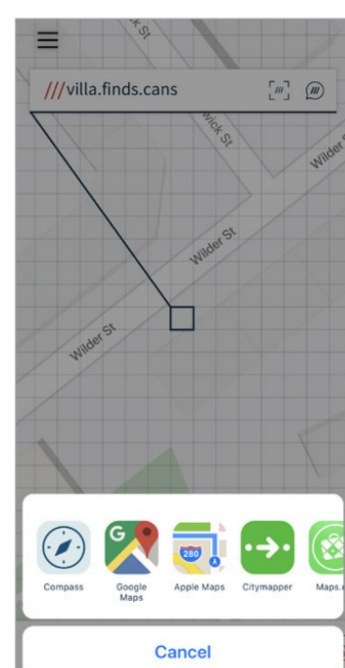
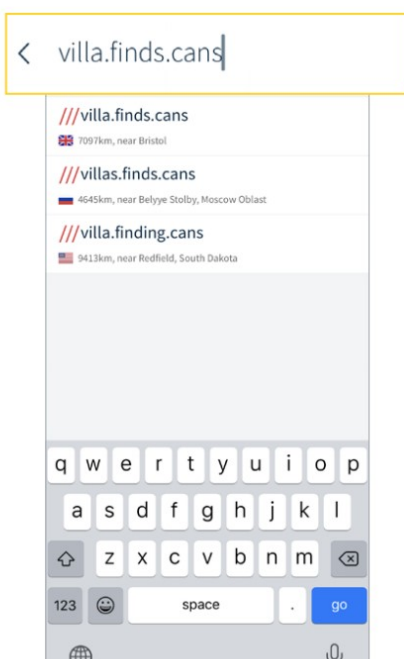

Long Route Directions

From the Turner Hall, go North East along Church Road, and continue to the junction

1. How far is it to Finstock? _____

Follow the Wychwood Way footpath signs, and continue along the footpath

2. What animal is kept in the fields to the North? _____

3. What colour is the water cover at the grid reference 392 139, or the what3words award.unleashed.observers.? _____

4. What colour is the 30cm tall wooden post to the left, around 50m from the corner of the path? _____

5. What type of bush is growing around 10m before the gate? _____

Keeping on the Wychwood Way, continue past the gate

6. From the warning sign on the gate onwards, how many posts are there along the footpath that aren't obscured from view by plants? _____

Continue through the field boundary. At the split of the path take the path on a bearing of 047° NNE and continue through the woods

7. 75m from the start of the wooded area, where the path gets a bit narrower, what type of tree is above you? _____

Continue along the path to the gate

8. What is the phone number on the footpath signs? _____

At the end of the field continue straight for 5m and take the path to the right of the fork. At the second fork, also take the path to the right. Continue to take the path to stay along the edge of the wooded area

9. What is the name of the house opposite you as you reach the main road in East End? _____

Go North West through East End

10. What sweet can be found just before Sturt Wood? _____

Turn South West from the main road along the footpath towards North Leigh. At any of the forks in the footpath, continue along the path next to the fence, on a South West bearing

11. Draw the 'Step into Cotswold' badge found on the gate (There's space at the end of the questions!)

Follow the footpath to the edge of the next field

12. What piece of armour is on the public footpath sign? _____

Take the footpath to the West until you get to the field boundary

13. Take a photo of you and/or your walking group doing a jump pose at the grid reference 395 148

14. At the field boundary, what landmark can you see at the bearing of 210°S?

Follow the footpath sign along the field. Continue through the field boundaries, following the footpath at a bearing of 320° NW

At the break in the hedge line, follow the footpath across two fields and through the trees at a bearing of 280°W

15. Why have the grass edgings been left? _____

16. What can you hear when you get to the trees at the end of the second field?

At the bottom of the hill walk North

17. What is there at grid reference 385 147 or what 3 words tips.utter.goods?

Take the footpath to the North West for 30m. At the break in the hedge line take the South West footpath

18. You've just climbed a big hill! Before you get take a rest look at your map and work out how high you've climbed from the river _____

Please read all the following instructions before moving. You need to cross the road, but safely;

At the road turn left, walking on the grass verge.

Cross to the island triangle of grass in the middle of the junction.

Walk to the lowest point of the grass triangle.

Then walk downhill on the LEFTHAND side of the road, taking care.

The footpath is 30m along the road, on the left. It's a bit hidden and is after the second sticky up tree.

Take the footpath through the field to the West

Cross the small bridge and continue in a South West direction

19. What is the name on top of the barn? (DON'T go into the farm) _____

Follow the footpath South West, parallel to the ditch/river, along the concrete and through the grass (NOT towards the farm buildings) and continue through the field

20. What are the uniformly planted trees halfway up the field, to the south?

Continue to the small wooded area (the path is a semi-circle inside it), and exit the woods in a Southerly direction

Follow the edge of the field South, and continue following the footpaths in a Southerly direction

- 21. Take a photo of you or your walking group so it looks like you're pushing some trees (use perspective!)**

Turn South East onto North Leigh Lane and continue towards New Yatt

- 22. What colour is the footpath sign? _____**

- 23. You're currently on a bridleway – what does this mean and what is the symbol on the map for it (there's space to draw it at the end!)?**

- 24. 10m along from the fork in the path/footpath sign, what is the tree on your left?**

- 25. How many crosses are there on the side of the second stone building on the left at New Yatt Farm? _____**

Just before you get to the no entry sign on your left, follow the gravel track East (there is a footpath sign on your right!)

- 26. How many barrels are by the shed? _____**

As you round the corner and see the house stick to the trees on your left and continue to the small footpath in front of you (it's a bit overgrown, sorry!)

- 27. What company made the gate? _____**

Cross the wooden bridge and take the footpath to the East (in the direction of the pylons)

- 28. What colour are the window frames of the C6 building? _____**

Go through the gate and when you reach the house at the end of the footpath, walk South West

- 29. What colour is the D4 door? _____**

- 30. What is the speed limit of New Yatt Road? _____**

Leave the New Yatt Business Centre and cross the road carefully toward the metal gate opposite the bridleway sign

Go over the stile and take the path to the South through 3 fields until you reach the metal gate

- 31. What is the small tree to the right of the next stile? _____**

- 32. How many posts are between the stile and the next field boundary? _____**

- 33. What is the website you find along the path? _____**

Cross the stile and follow the path

34. What is the flap on the stile for? _____

Walk through the woods, and then walk straight across the field at a bearing of 143° SE. This will take you straight across the farmers crops however this is where the footpath takes you, and where the farmer wants you to walk.

When you begin walking you need to aim for the middle tree of the three across the field, with the CD hanging from it.

(Please note that these crops may have been harvested by the time you get to them!)

Go through the gate and continue South through two fields

35. What is the tree along the hedgerow at Brim's Ditch? (It's not an actual ditch, and is before the bridge!) _____

36. Once over the stile, what colour is the wall of the farm building at a bearing of 080°E? _____

Cross the road carefully to the footpath opposite and continue along the foot path towards the South

37. Is this area of woodland naturally grown or planted by people? _____

38. Look at the trees. Which side does the green moss grow? And which side does the white lichen grow? _____

Exit the woods and continue along the footpath on the East side of the field boundary, in a Southerly direction

39. How many trees are in the middle of the second field? _____

At grid reference 385 116 take the path on a bearing of 145° SE (continue into the woods)

40. What is the plastic tube around the trees for? _____

41. Take a photo of you doing the tree pose in the double tree at a bearing of 100°E, opposite the end of the footpath

Take the bridleway North

42. Draw and name the leaves of five trees you can see (try to use ones you haven't yet had to answer a question about!) - There's space at the end of the questions

43. How far have you climbed while walking in the woodland? _____

Cross the road and enter North Leigh, continuing North

44. How far is it to Long Hanborough train station? _____

45. What is in the window of 83 Common Road? _____

46. On a Saturday, what time does the 233 bus stop at Minster Lovell White Hart (in the direction of Woodstock to Burford)? _____

47. On a Tuesday what time does the post get collected? _____

At grid reference 386 129 turn East and take the footpath

48. What are the numbers on the two lamp posts on the footpath? _____

Turn East along Park Road

49. How much is it to repair/dry clean a full-length coat? _____

50. What is in the garden of 31 Park Road that you wouldn't normally expect to see?

51. How many decorative concrete squares are on the front of number 66 and 68 Park Road? _____

Take the footpath towards the Church at the grid reference 393 129

52. What is rusting in the field to the west of the footpath? _____

53. Once you have passed the field boundary, what can you see to the North West?

Continue along the footpath in a North West direction

54. How many full rectangles are on the mesh part of the gate to your left on Church Road? _____

Walk carefully North East along Church Road

55. Name three people who the church gate is in memory of: _____

11.	42.
23.	

Summer Orienteering

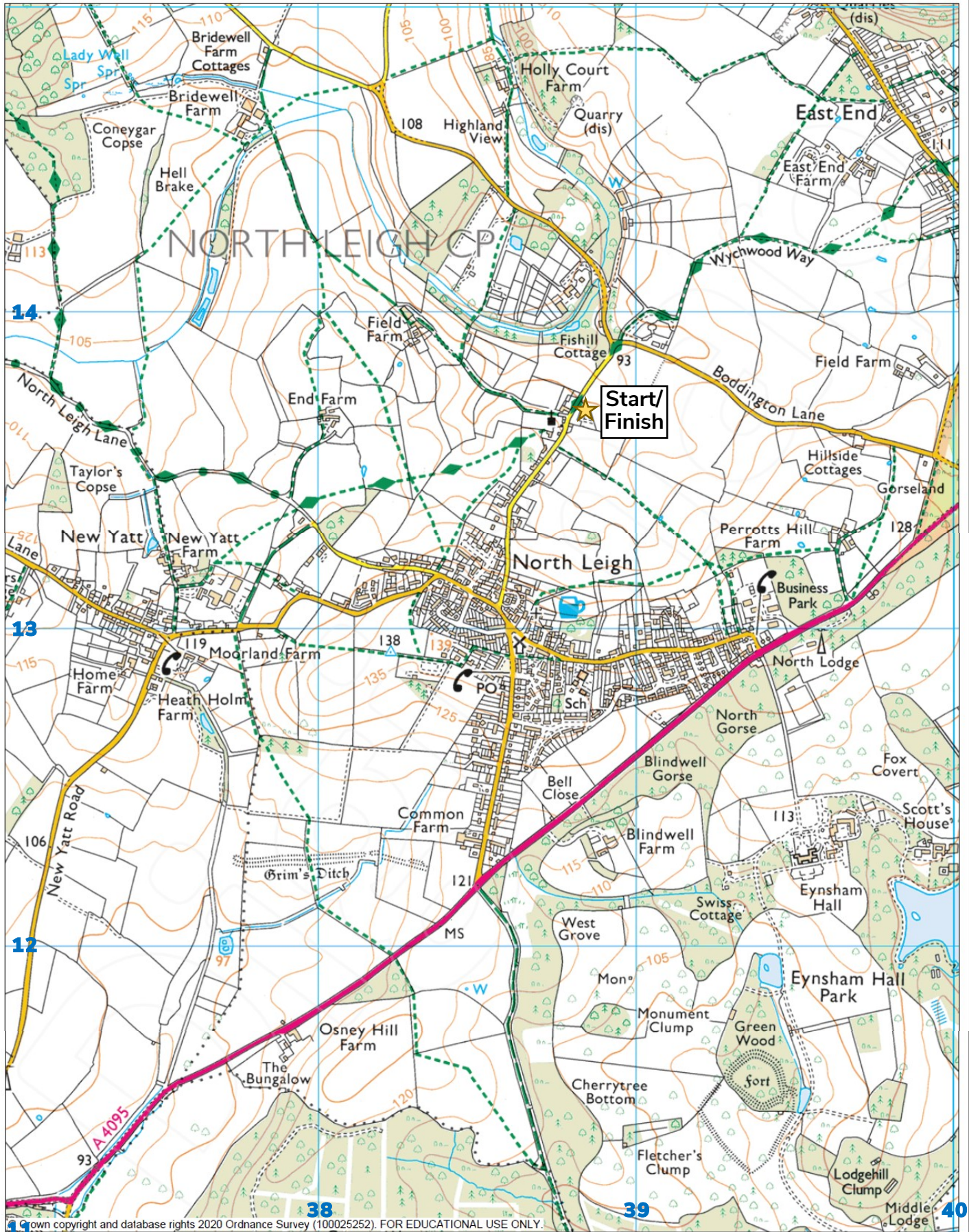

© Crown copyright and database rights 2020 Ordnance Survey (100025252). FOR EDUCATIONAL USE ONLY.

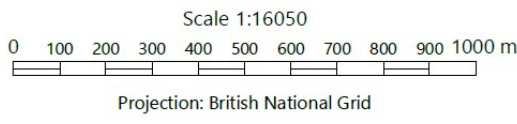

LONG ROUTE - Summer Orienteering - Route for if you get lost

Take this with you, but don't look at it unless you are lost!

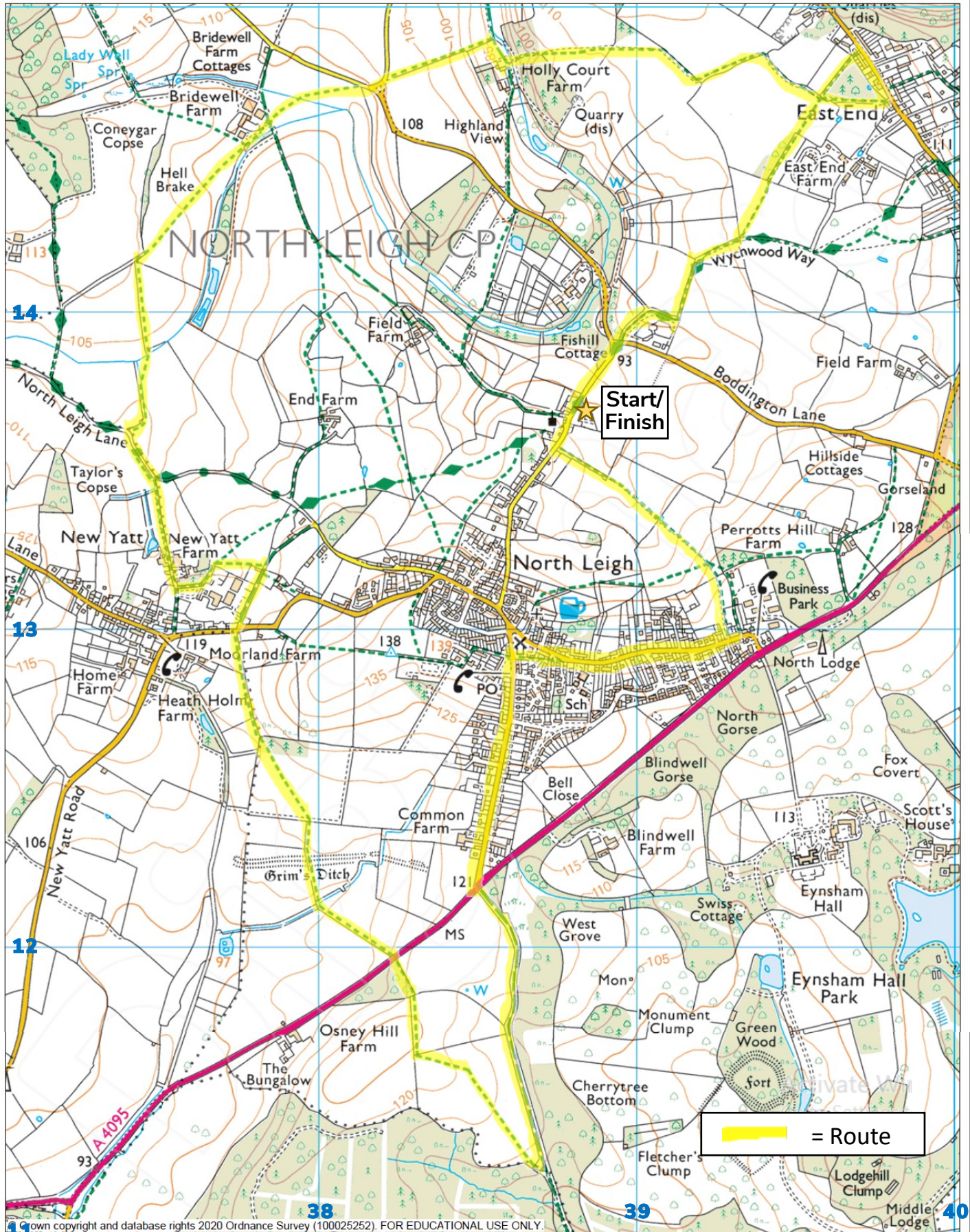

© Crown copyright and database rights 2020 Ordnance Survey (100025252). FOR EDUCATIONAL USE ONLY.



Scale 1:16050

0 100 200 300 400 500 600 700 800 900 1000 m

Projection: British National Grid

